

LED



createchange



FEATURES

- Enclosed high efficiency lens features linear prism acrylic and provides visual comfort and high performance without pixelation
- Appropriate for schools, medical facilities, dining areas, locker rooms, and public spaces
- Enclosed lens protects against intrusion of contaminants
- High performance matte white paint standard.
- Optional Antimicrobial® paint (AM option) resists bacterial growth on exposed painted surfaces
- Lens gasket option and wet location listing available
- 60,000 hour LEDs at L80 (up to 150,000 projected life) for reduced life cycle maintenance costs
- Four LED color choices with excellent color consistency and 82 CRI
- Controls compatible for code compliance and energy savings
- Low W/ft² ratio typically meets most restrictive lighting power density codes
- Fixed output, step dimming or 0-10V dimming drivers
- Electrical components accessible from below the ceiling with modular replaceability
- DLC® (DesignLights Consortium) Qualified - see www.designlights.org
- Five year warranty

PROJECT INFORMATION

Project Name _____

Type _____

Catalog No. _____

Date _____

CONSTRUCTION

Luminaire housing and end caps are die formed code gauge cold rolled steel. Reflector is stiffened with linear forms, profiled to a precision curve. High transmission extruded acrylic enclosed lens features linear prisms custom frost for high efficacy without pixelation.

SHIELDING

Thermoplastic light seals snap into the housing at both ends of the lens to prevent light leaks. Lens hinges down for easy access to LED module and electrical components. Optional gasketing available to surround the lamp cavity (standard when Wet Location option is ordered^{5,6}).

FINISH

All reflective surfaces are finished after fabrication with unique formula high reflectivity matte white paint for soft, uniform indirect illumination. Optional Antimicrobial® paint (AM option) resists bacterial growth on exposed painted surfaces.

INSTALLATION

An access plate is furnished with each luminaire for fast wiring access without the necessity to open the fixture or wireway.

CEILING COMPATIBILITY

Luminaire fits recessed exposed Grid ceilings (G); four integral NEC compliant T-bar clips are standard. Can be placed in Slot Grid (SG) style ceiling with regress 3/8" above ceiling plane. A Flange Kit (FK) accessory is available for recessed hard ceiling applications. Surface Mount (SM) option allows placement below ceiling plane. Cable Mount (CM) option allows suspension below ceiling plane.

CERTIFICATION

All luminaires are built to UL1598 and 2108 standards, and bear appropriate CSA labels. Damp location is standard. IC label standard. Void when using ELL14 and through wiring. Wet location listing available on all configurations^{5,6}. Emergency-equipped fixtures labeled UL 924 and Dry Location unless specified. Adheres to LM70, LM80, and TM21 industry standards. DLC® (DesignLights Consortium) Qualified. Please refer to the DLC website for specific product qualifications at www.designlights.org.

WARRANTY

Five year warranty (Terms and Conditions apply).

ORDERING INFORMATION

EXAMPLE LTRE24-35MLG-RFA-ESDU

LTRE		24		-		RFA		-		U		-	
MODEL		COLOR TEMPERATURE		CEILING TYPE		SHIELDING		VOLTAGE		OPTIONS			
LTRE	Transition® LED Enclosed High Efficiency Architectural Lens	30	3000K	G	Grid Lay-in ¹	RFA	Ribbed Frosted Acrylic	U	120V-277V	C388	3-Wire Flex	C488	4-Wire Flex
		35	3500K	SM	Surface Mount					C588	5-Wire Flex	GLR	Fast Blow Fuse
		40	4000K	CM	Cable Mount ²					ELL14	Emergency Battery Pack Installed, 1400 Lumens ^{3,5,6}	AM	Antimicrobial® Paint ⁴
		50	5000K							G1	Lens Gasketing	WL	Wet Location ^{5,6}
										EOR	End of Row (SM and CM only. Provides end wiring access for continuous row mounting.)	INT	Intermediate (SM and CM only. Provides ends with wiring access for continuous row mounting.)
										CP	Chicago Plenum		

SIZE
24 2' x 4'

LUMEN OUTPUT
LW Low Watt
ML Medium Lumen
HL High Lumen
VL Very High Lumen
XL Extra High Lumen⁷

DRIVER
E Fixed Output
ESD Step Dimming
ED 0-10V Dimming
ED1 0-10V Dimming up to 1%
LUT5 5-Series EcoSystem LED driver

PRODUCT AVAILABILITY

SIZE	LUMEN PACKAGE	NOMINAL LUMENS	NOMINAL WATTS	LUMENS PER WATT
24	LW	4275-4875	38	114-130
24	ML	4650-5324	41	112-129
24	HL	5575-6475	52	108-126
24	VL	7225-8250	67	109-124
24	XL	8350-9650	81	103-119

Nominal lumen range represents 3000K through 5000K. Lumens vary according to color temperatures and other factors. See specific photometric test(s).

ACCESSORIES (ORDER SEPARATELY)

- FK24** 2' x 4' Single Flange Kit (Shipped separately)
- CM48Y2SC3F-KIT** 48" Cable Mount Kit for 2' wide Cable Mount fixtures, 3 Wire

¹ For drywall order FK24 accessories separately.

² Order hanger accessories separately.

³ For compatibility with Dual-Lite LiteGear® inverters in lieu of installed battery pack, contact Hubbell Lighting Representative.

⁴ Optional Antimicrobial® paint (AM option) resists bacterial growth on exposed painted surfaces.

⁵ Not available on Surface Mount or Cable Mount ceiling types.

⁶ WL not available with battery pack.

⁷ XL not available with ELL14.

Test L071409302 Test Date 8/12/2014

PHOTOMETRIC DATA

LUMINAIRE DATA

Luminaire	LTRE24-35MLG-RFA-EDU LTRE Transition Enclosed LED, Recessed Architectural 2 x 4 led with frosted linear prism lens
Ballast	EVERLINE D15CC55UNVT-C
Ballast Factor	1.00
Lamp	LED
Fixture Lumens	4649
Watts	41.40
Mounting	Recessed
Shielding Angle	0° = 90 90° = 90
Spacing Criterion	0° = 1.19 90° = 1.30
Luminous Opening in Feet	Length: 3.94 Width: 1.85 Height: 0.00

ZONAL LUMEN SUMMARY

Zone	Lumens	% Lamp	% Fixt.
0-30	1198	25.8	25.8
0-40	1961	42.2	42.2
0-60	3496	75.2	75.2
0-90	4649	100.0	100.0
0-180	4649	100.0	100.0

ENERGY DATA

Total Luminaire Efficiency	100.0%
Total Lumens per Watt	112
IESNA RP-1-1993 Compliance	Non-Compliant
Comparative Yearly Lighting Energy Cost per 1000 Lumens	\$2.12 based on 3000 hrs. and \$0.08 per KWH

INDOOR CANDELA PLOT

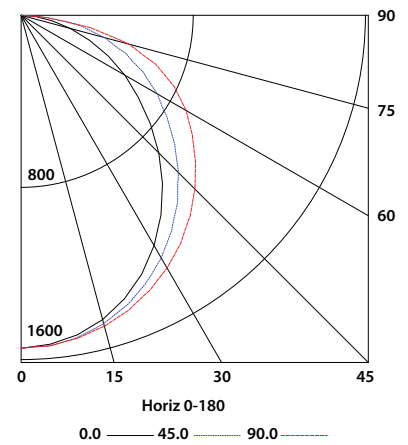

Test L071409304 Test Date 8/13/2014

LUMINAIRE DATA

Luminaire	LTRE24-35VLG-RFA-EDU LTRE Transition Enclosed LED, Recessed Architectural 2 x 4 led with frosted linear prism lens
Ballast	EVERLINE D23CC90UNVT-F
Ballast Factor	1.00
Lamp	LED
Fixture Lumens	7243
Watts	66.68
Mounting	Recessed
Shielding Angle	0° = 90 90° = 90
Spacing Criterion	0° = 1.18 90° = 1.31
Luminous Opening in Feet	Length: 3.94 Width: 1.85 Height: 0.00

ZONAL LUMEN SUMMARY

Zone	Lumens	% Lamp	% Fixt.
0-30	1886	26.0	26.0
0-40	3087	42.6	42.6
0-60	5502	76.0	76.0
0-90	7243	100.0	100.0
0-180	7243	100.0	100.0

ENERGY DATA

Total Luminaire Efficiency	100.0%
Total Lumens per Watt	109
IESNA RP-1-1993 Compliance	Non-Compliant
Comparative Yearly Lighting Energy Cost per 1000 Lumens	\$2.02 based on 3000 hrs. and \$0.08 per KWH

INDOOR CANDELA PLOT

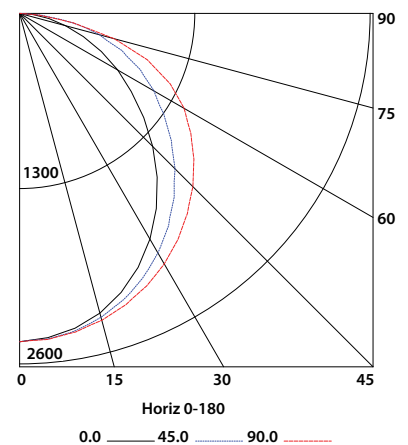

Test L071409305 Test Date 8/13/2014

LUMINAIRE DATA

Luminaire	LTRE24-35XLG-RFA-EDU LTRE Transition Enclosed LED, Recessed Architectural 2 x 4 led with frosted linear prism lens
Ballast	EVERLINE D23CC90UNVT-F
Ballast Factor	1.00
Lamp	LED
Fixture Lumens	8353
Watts	81.23
Mounting	Recessed
Shielding Angle	0° = 90 90° = 90
Spacing Criterion	0° = 1.19 90° = 1.31
Luminous Opening in Feet	Length: 3.94 Width: 1.85 Height: 0.00

ZONAL LUMEN SUMMARY

Zone	Lumens	% Lamp	% Fixt.
0-30	2146	25.7	25.7
0-40	3513	42.1	42.1
0-60	6271	75.1	75.1
0-90	8353	100.0	100.0
0-180	8353	100.0	100.0

ENERGY DATA

Total Luminaire Efficiency	100.0%
Total Lumens per Watt	103
IESNA RP-1-1993 Compliance	Non-Compliant
Comparative Yearly Lighting Energy Cost per 1000 Lumens	\$2.33 based on 3000 hrs. and \$0.08 per KWH

INDOOR CANDELA PLOT

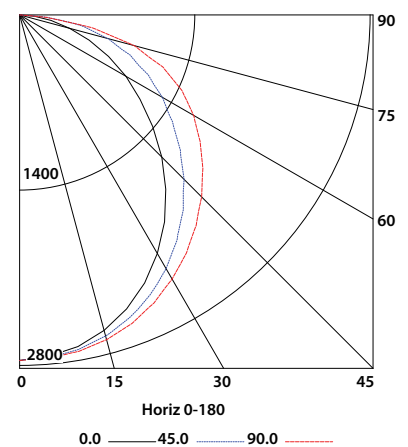

DIMENSIONAL DATA — GRID

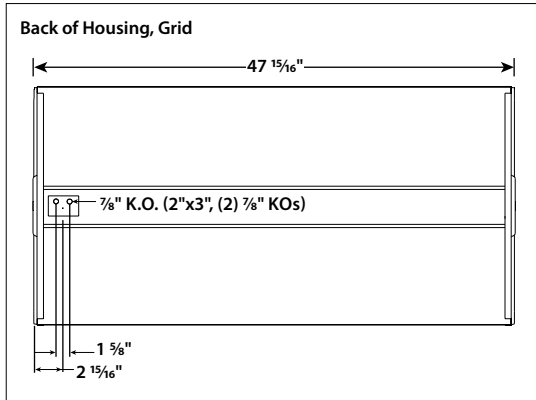
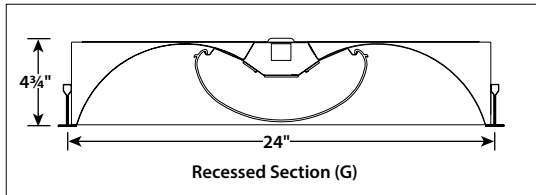

CEILING COMPATIBILITY

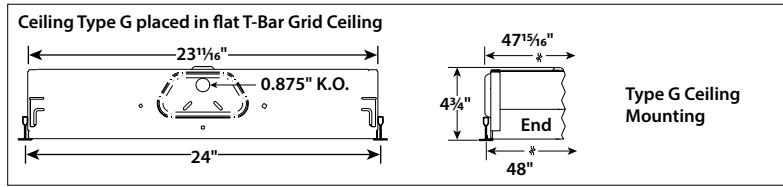

For lay-in installation in exposed grid ceilings. Maximum tee widths of 1" and maximum heights of 1 1/2" allowed.

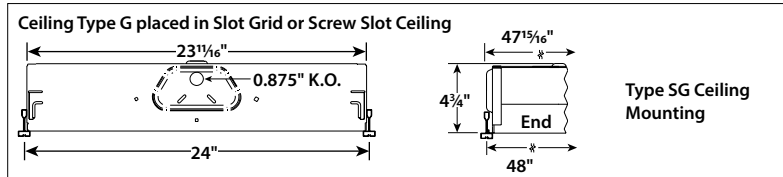

For 3/8" slot grid type ceilings. Luminaire will be regressed 3/8" from the horizontal surface of the tee.

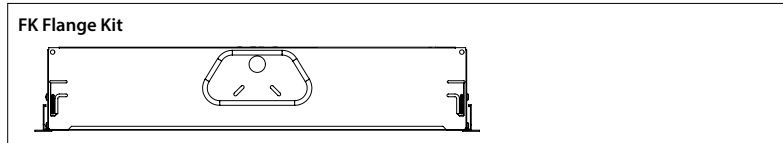

For hard ceiling applications, fixtures must be ordered with a flange kit that wires directly into the concealed ceiling opening for a clean finished appearance. For row configurations contact your local Columbia Representative.

Flange kit cut out dimension for single FK24: 24 3/8" x 48 3/8"

DIMENSIONAL DATA — SURFACE MOUNT

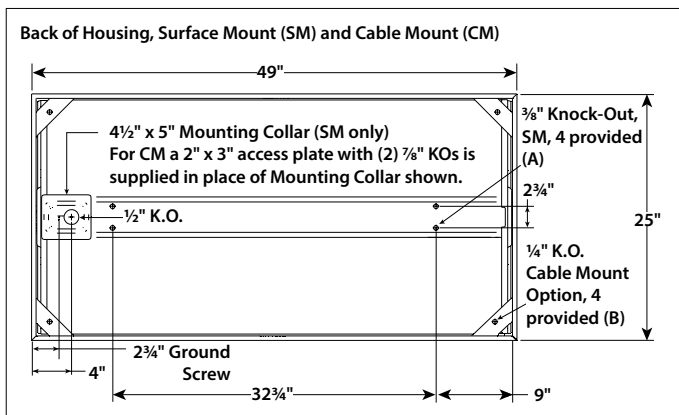
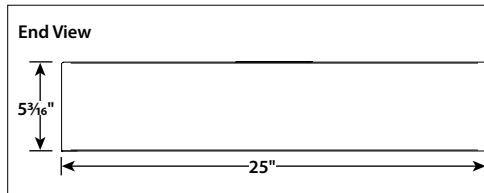
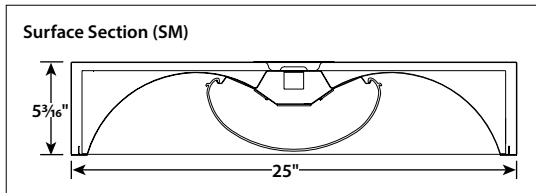

Surface Mount:
Order SM ceiling type. Mounting collar required for surface mounting. (4) Mounting knock-outs, 3/8", provided in center channel as indicated at left, marked "A".

Cable Mount:
Order CM ceiling type. Use CM48Y2SC3F-KIT 48" Cable Mount Kit for 2' wide SM trim fixtures. Mounting holes are provided in diagonal straps shown at left, marked "B".

NOTE: All dimensions are in inches; dimensions and specifications are subject to change without notice. Please consult factory or check sample for verification.