

User Guide



Combination Photoelectric
Smoke & Carbon Monoxide Alarm
with Hardwire Interconnect

Model 30CUAR



COMBINATION ALARM



Helps Reduce Cooking
Nuisance Alarms



P/N: G-000013-00 Rev. A

- 120V HARDWIRE INTERCONNECT
- AA BATTERY BACKUP (AC POWER REQUIRED)
- SELF-TESTING (SEE SECTION 10)

Thank You for Purchasing this Kidde Alarm

Hardwired for 120V AC, this model includes two replaceable AA backup batteries. It also contains HUSH™ to temporarily silence nuisance alarms, and “self-testing” features (see section 10).

Teach children how to respond to the alarm and that they should never play with the unit.

This alarm is a multi-criteria device designed to detect both smoke and carbon monoxide from any source of combustion in a residential environment. It is not designed for use in a recreational vehicle (RV) or boat.

NOTE: Please thoroughly read this user guide and save the document for future reference and to pass on to any subsequent owner. Images are representative only. Actual product may vary slightly.

The National Fire Protection Association (NFPA) and the manufacturer recommend replacing this alarm after ten years.

Product Support: 1-800-880-6788

Please write down the below information and have this at hand when you call.

Date Code (on back): _____

Date of Purchase: _____

Where Purchased: _____

Date to Replace: _____

Contents

1. Smoke Alarm: What To Do When The Alarm Sounds 4
2. Carbon Monoxide Alarm: What To Do When The Alarm Sounds 5
3. Other Alarm Visual And Audible Indicators 6
4. Troubleshooting Guide 7
5. Introduction, Product Features And Specifications 8
6. Limitations Of Smoke And Carbon Monoxide Alarms 9
7. Recommended Locations For Smoke And Carbon Monoxide Alarms 11
8. Locations To Avoid 14
9. Wiring / Installation / Activation 15
10. Operation And Testing. 20
11. Recognizing Nuisance Alarms 21
12. Battery Back Up 22
13. General Carbon Monoxide (CO) Information 23
14. Cleaning Your Alarm 25
15. Good Safety Habits 26
16. Service And Warranty 29

1. Smoke Alarm: What To Do When The Alarm Sounds

The smoke alarm pattern is three long beeps, a 1.5 second pause, and three long beeps repeating.

The red LED blinks in time with the alarm pattern only on the alarm(s) that detected the hazard (initiating alarm).

The smoke alarm takes precedence when both smoke and carbon monoxide are present.

- Alert small children in the home as well as anyone else that might have difficulty recognizing the importance of the alarm sounding or that might have difficulty leaving the area without help.
- Plan two ways out! Leave immediately by your escape plan. Don't waste time getting dressed or picking up valuables.
- While leaving, don't open any inside door without first feeling its surface. If hot, or if you see smoke seeping through cracks, don't open that door! Instead, use your alternate exit. If the inside of the door is cool, place your shoulder against it, open it slightly and be ready to slam it shut if heat and smoke rush in.
- If the escape route requires you to go through smoke, stay close to the floor where the air is cleaner. Crawl if necessary, and breathe shallowly through a cloth, wet if possible.
- Once outside, go to your selected meeting place and make sure everyone is there.
- Call the fire department or 911 from your cell phone outside, or from your neighbor's home-not from yours!
- Don't return to your home until the fire officials say that it is all right to do so.

NOTE: See Section RECOGNIZING NUISANCE ALARMS, for nuisance alarm situations.

2. Carbon Monoxide Alarm: What To Do When The Alarm Sounds

The carbon monoxide (CO) alarm pattern is four quick beeps repeating every 5 seconds. The red LED blinks in time with the alarm pattern only on the alarm(s) that detected the hazard (initiating alarm). On DC power, after 4 minutes in CO alarm the alarm pattern will only occur every 60s.

 **WARNING: ACTUATION OF YOUR CO ALARM INDICATES THE PRESENCE OF CARBON MONOXIDE (CO) WHICH CAN KILL YOU. IF ALARM SIGNAL SOUNDS:**

1) Operate the Test/Hush™ button. NOTE: Pressing the button on the alarming unit will silence the alarm notification. If the unit goes into alarm mode again within six minutes, it is sensing high levels of CO which can quickly become a dangerous situation.

2) Call your emergency services (Fire Department or 911).

EMERGENCY PHONE #: _____

3) Immediately move to fresh air—outdoors or by an open door/window. Do a head count to check that all persons are accounted for. Alert small children in the home as well as anyone else that might have difficulty recognizing the importance of the alarm sounding or that might have difficulty leaving the area without help. Do not reenter the premises or move away from the open door/window until the emergency services responders have arrived, the premises have been aired out, and your alarm remains in its normal condition.

4) After following steps 1-3, if the alarm reactivates within a 24 hour period, repeat steps 1-3 and call a qualified appliance technician to investigate sources of CO from fuel burning equipment and appliances, and to inspect for proper operation of equipment.

NOTE: See Section RECOGNIZING NUISANCE ALARMS, for nuisance alarm situations.

If problems are identified during this inspection, have the equipment serviced immediately. Note any combustion equipment not inspected by the technician and consult the manufacturer's instructions, or contact the manufacturer directly for more information about CO safety and the equipment. Make sure that motor vehicles are not, or have not been, operating in a garage attached or adjacent to the residence. Never restart the source of a CO problem until it has been corrected. Never ignore the sound of the alarm!

3. Other Alarm Visual And Audible Indicators

Operational Mode	Visual Indications	Audible Indications	Action/Note
Normal (standby)	AC power: Green LED on continuously. DC power: Green LED blinks approx every 60 sec.		
Test (button press when no alarm condition is present) (Note: Test is very loud, stand a few feet away.)	Red LED blinks in time with alarm pattern.	<ul style="list-style-type: none"> • Single beep. • 3 long beeps, pause, 3 long beeps, 4 quick beeps, pause, 4 quick beeps. 	Perform button press once a week to verify proper alarm operation.
Smoke or CO Alarm Memory (unit has experienced a smoke or CO alarm event, or has detected 100ppm CO or greater.)	Smoke: Red LED blinks every 15 sec. CO: 2 red LED blinks every 15 sec.		NOTE: Alarm memory is only retained for 24 hrs. Push button to clear Alarm Memory.
Smoke Alarm Hush™ Mode	Red LED blinks every 2 sec. (only on the initiating alarm)	After button push, smoke alarm pattern stops. (If there is too much smoke to allow Hush™, smoke alarm pattern continues.)	This feature is to be used only when a known alarm condition, such as smoke from cooking, activates the alarm. Push button during Hush™ to clear Hush™ and perform a test.
CO Alarm Reset	None.	After button push: CO alarm pattern stops.	Unit is confirming if CO is present or if it experienced a nuisance situation. Re-alarm means danger. Move to fresh air and call 911.

Operational Mode	Visual Indications	Audible Indications	Action/Note
Initiating Alarm (multiple alarms in an interconnected system)	Red LED blinks in time with alarm pattern indicating that this is the unit initiating the alarm in an interconnected, multiple alarm, system. NOTE: It is possible for more than one unit to detect a hazard and become an initiating alarm unit (Red LED blinking).	Unit in either Smoke or CO alarm mode.	

4. Troubleshooting Guide

If you require further information please contact Product Support at 1-800-880-6788 or write us at: Kidde, 1016 Corporate Park Drive, Mebane, NC 27302. Our internet address is www.kidde.com.

Trouble Condition	Visual Indications	Audible Indications	Action
False Low Battery (AC power connected before backup batteries activated)	None	Chirp every 60 sec.	* Pull the battery pull tab to activate the backup batteries.
Low Battery	Amber LED blinks every 60 sec.	Chirp every 60 sec.	* Push button once to silence for 24 hrs. (Push button again to clear Hush™ and perform a test.) Note: 7 days after Low Battery begins, the notifications cannot be silenced. * Replace batteries as soon as possible.
Smoke Sensor Fault	Amber LED blinks every 60 sec.	3 chirps every 60 sec.	* See Cleaning Your Alarm section. * Push button once to attempt to reset the unit. * If error continues, remove alarm, dispose unit, and replace as soon as possible.
CO Fault	Amber LED blinks 2 times every 60 sec.	3 chirps every 60 sec.	* Push button once to attempt to reset the unit. * If error continues, remove alarm, dispose unit, and replace as soon as possible.
Fatal Fault	Amber LED blinks 3 times every 60 sec.	3 chirps every 60 sec.	* Push button once to attempt to reset the unit. * If error continues, remove alarm, dispose unit, and replace as soon as possible.

Trouble Condition	Visual Indications	Audible Indications	Action
End of Unit Life	Amber LED blinks 2 times every 60 sec.	2 chirps every 60 sec.	* Push button once to silence for 24 hrs. (Push button again to clear Hush™ and perform a test.) Note: 7 days after End of Unit Life begins, the notifications cannot be silenced. * Remove alarm, dispose unit, and replace as soon as possible.
MCU Failure	None	Constant Tone	* Remove alarm, dispose unit, and replace as soon as possible.
Stuck Button	Amber LED blinks 4 times every 60 sec.	3 chirps every 60 sec.	* Push button to dislodge it from being stuck. If button cannot be unstuck, remove alarm, dispose unit, and replace as soon as possible.

5. Introduction, Product Features And Specifications

Introduction

This alarm detects products of combustion using a photoelectric sensor and carbon monoxide using an electrochemical cell. Many times throughout this User Guide, we will refer to Carbon Monoxide as "CO."

Ten (10) years after the unit was installed, powered up, and tested, this unit will automatically alert you that it is time to replace the unit. This is called "End of Unit Life" mode. See Troubleshooting Guide. To help identify the date to replace the unit, a label has been affixed to the side of the alarm. Write the "Install date" in the space provided, and then write in the "Replace by" date (10 years from initial power up) in permanent marker on the label prior to installing the unit. Two labels have been provided that have important information on what to do in case of a CO alarm. Place one label at eye level on a wall near the alarm after it is mounted, and one near a fresh air source such as a door or window.

Product Features and Specifications:

- Powered by 120VAC (60 Hz, 42 mA max) wire-in connector with 2 AA backup batteries
- Reduced nuisance alarms
- Self-testing (see section 10)
- Easy installation
- Smoke Alarm Hush™
- Smoke Sensor: Photoelectric
- CO Sensor: Electrochemical
- Temperature Operating Range: 40°F (4.4°C) to 100°F (37.8°C)
- Humidity Operating Range: 10 to 95% RH, non-condensing
- Audible Alarm: 85+ dB at 10', 3.0 to 3.5 KHz pulsing alarm

6. Limitations Of Smoke And Carbon Monoxide Alarms

⚠ WARNING: PLEASE READ CAREFULLY AND THOROUGHLY

- Life safety from fire in residential occupancies is based primarily on early notification to occupants of the need to escape, followed by the appropriate egress actions by those occupants.
- There are situations where a smoke alarm may not be effective to protect against fire as stated in the NFPA Standard 72. For instance:
 - a) smoking in bed
 - b) leaving children home alone
 - c) cleaning with flammable liquids, such as gasoline
- Fire warning systems for dwelling units are capable of protecting about half of the occupants in potentially fatal fires. A smoke alarm may not be effective in some situations, such as during incendiary fires where the fire grows so rapidly that an occupant's egress is blocked even with properly located smoke alarms, or when victims are intimate with the fire (for example, when a person's clothes catch fire while cooking), too old or young, or physically or mentally impaired such that they cannot escape even when warned early enough that escape should be possible. For these people, additional strategies such as protection-in-place or assisted escape or rescue are necessary.*
- This model meets the latest residential smoke alarm standards, which includes enhanced resistance to nuisance alarms from cooking. Industry experts recommend that both ionization and photoelectric smoke alarms be installed to help ensure optimal detection of the various types of fires that can occur within the home. Ionization sensing alarms may detect invisible fire particles (associated with fast flaming fires) sooner than photoelectric alarms. Photoelectric sensing alarms may detect visible fire particles (associated with slow smoldering fires) sooner than ionization alarms.
- A battery powered alarm must have a battery of the specified type, in good condition and installed properly (this model includes two AA replaceable backup batteries).
- Smoke alarms must be tested regularly to make sure the battery and the alarm circuits are in good operating condition.
- Smoke alarms cannot provide an alarm if smoke does not reach the alarm. Therefore, smoke alarms may not sense fires starting in chimneys, within walls, on roofs, on the other side of a closed door or other obstructions.
- If the alarm is located outside the bedroom or on a different floor, it may not wake up a sound sleeper.
- The use of alcohol or drugs may also impair one's ability to hear the smoke alarm. For optimal detection, a smoke alarm should be installed in each sleeping area on every level of a home.

This alarm is not intended to alert hearing impaired individuals.

* Reference National Fire Protection Association (NFPA) standard 72

⚠ WARNING: PLEASE READ CAREFULLY AND THOROUGHLY

- **IMPORTANT:** This alarm is designed to detect carbon monoxide gas from ANY source of combustion. It is NOT designed to detect any other gas.

⚠ CAUTION: This alarm will only indicate the presence of carbon monoxide gas at the sensor. Carbon monoxide gas may be present in other areas. Never restart the source of a CO problem until it has been fixed. **NEVER IGNORE THE ALARM!**

⚠ WARNING: THIS PRODUCT IS INTENDED FOR USE IN ORDINARY INDOOR LOCATIONS OF FAMILY LIVING UNITS. IT IS NOT DESIGNED TO MEASURE COMPLIANCE WITH OCCUPATIONAL SAFETY AND HEALTH ADMINISTRATION (OSHA) COMMERCIAL OR INDUSTRIAL STANDARDS. IT IS NOT SUITABLE FOR INSTALLATION IN HAZARDOUS LOCATIONS AS DEFINED IN THE NATIONAL ELECTRIC CODE. IT IS NOT DESIGNED FOR USE IN A RECREATIONAL VEHICLE (RV) OR BOAT.

- The installation of this device should not be used as a substitute for proper installation, use, and maintenance of fuel burning appliances, including appropriate ventilation and exhaust systems.
- This alarm does not prevent CO from occurring, nor can it solve any existing CO problem.

⚠ WARNING: THIS DEVICE IS DESIGNED TO HELP PROTECT INDIVIDUALS FROM ACUTE EFFECTS OF CARBON MONOXIDE EXPOSURE. IT WILL NOT FULLY SAFEGUARD INDIVIDUALS WITH SPECIFIC MEDICAL CONDITIONS. IF IN DOUBT, CONSULT A MEDICAL PRACTITIONER. INDIVIDUALS WITH MEDICAL PROBLEMS MAY CONSIDER USING WARNING DEVICES WHICH PROVIDE AUDIBLE AND VISUAL SIGNALS FOR CARBON MONOXIDE CONCENTRATIONS UNDER 30 PPM. *

- This alarm has not been investigated for carbon monoxide detection below 70 PPM.
- This device requires a continuous supply of electrical power from a healthy battery or AC connection, depending on the model. It will not work without power.

* Reference Underwriters Laboratories (UL) standard 2034

7. Recommended Locations For Smoke And Carbon Monoxide Alarms

- Locate smoke alarms in all sleeping areas. Try to monitor the exit path as the bedrooms are usually farthest from the exit. If more than one sleeping area exists, locate additional alarms in each sleeping area.
- Locate additional alarms in stairways, because stairways act like chimneys for smoke and heat.
- Locate at least one alarm on every floor level.
- Locate an alarm in every bedroom.
- Locate an alarm in every room where electrical appliances are operated (i.e. portable heaters or humidifiers).
- Locate an alarm in every room where someone sleeps with the door closed. The closed door may prevent an alarm not located in that room from waking the sleeper.
- Smoke, heat, and combustion products rise to the ceiling and spread horizontally. Mounting the smoke alarm on the ceiling in the center of the room places it closest to all points in the room. Ceiling mounting is preferred in ordinary residential construction.

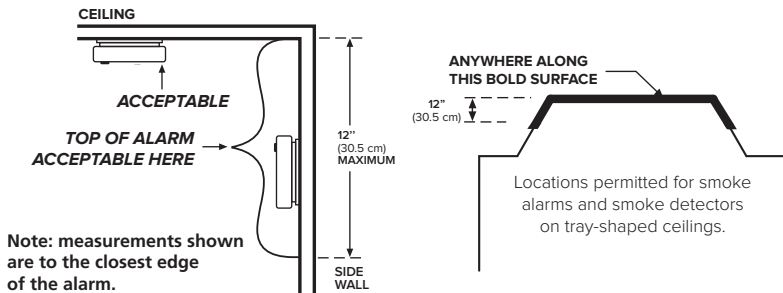
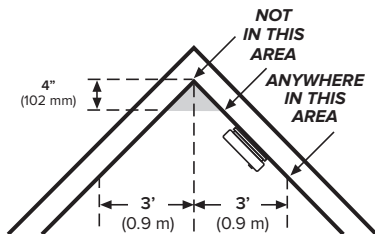
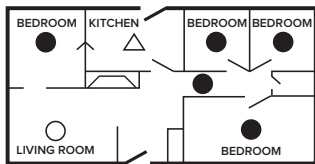

Figure 7-A

NFPA 72 states: "Smoke alarms in rooms with ceiling slopes greater than 1 ft in 8 ft (0.3m in 2.4 m) horizontally shall be located on the high side of the room." NFPA 72 states: "A row of detectors shall be spaced and located within 3 ft (0.9m) of the peak of the ceiling measured horizontally."

SINGLE FLOOR PLAN



MULTIPLE FLOOR PLAN

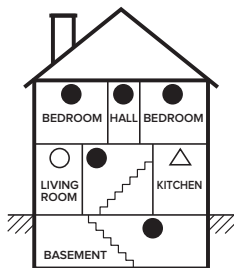

Figure 7-B

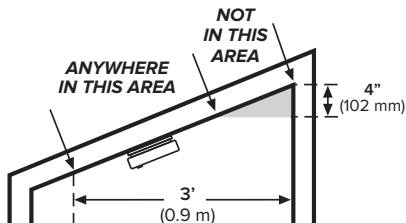

Figure 7-C

- For mobile home installation, select locations carefully to avoid thermal barriers that may form at the ceiling. For more details, see MOBILE HOME INSTALLATION section.
- When mounting the alarm on the wall, use an inside wall with the top edge of the alarm at a maximum of 12" (30.5 cm) below the ceiling.
- Put smoke alarms at both ends of a bedroom hallway or large room if the hallway or room is more than 30 feet (9.1 m) long.
- Install Smoke Alarms on sloped, peaked or cathedral ceilings at or within 3ft (0.9m) of the highest point (measured horizontally).
- Industry experts recommend a CO alarm be installed on each level of the home-ideally on any level with fuel burning appliances and outside of sleeping areas.

This equipment should be installed in accordance with the National Fire Protection Association's 72 (National Fire Protection Association, Batterymarch Park, Quincy, MA 02269).

Mobile Home Installation

Modern mobile homes have been designed and built to be energy efficient. Install smoke alarms as recommended above. In older mobile homes that are not well insulated compared to present standards, extreme heat or cold can be transferred from the outside to the inside through poorly insulated walls and roof. This may create a thermal barrier which can prevent the smoke from reaching an alarm mounted on the ceiling. In such units, install the smoke alarm on an inside wall with the top edge of the alarm a maximum of 12" (30.5 cm) below the ceiling.

If you are not sure about the insulation in your mobile home, or if you notice that the outer walls and ceiling are either hot or cold compared to the room air temperature, install the alarm on an inside wall. NFPA 72 (National Fire Protection Association) requires smoke alarms be installed in each sleeping area.

 WARNING: TEST YOUR ALARM OPERATION AFTER MOBILE HOME HAS BEEN IN STORAGE OR UNOCCUPIED, AND AT LEAST ONCE A WEEK DURING USE.

8. Locations To Avoid

(See Figures 7-A, 7-B, & 7-C for recommended locations)

- In the garage. Products of combustion are present when you start your automobile.
- Normal cooking may cause nuisance alarms. If a kitchen alarm is desired, it should have an alarm silence feature and should not be installed within 6 ft of cooking appliances.
- Do not install within 6 ft of heating appliances.
- Less than 4" (10cm) from the peak of an "A" frame type ceiling.
- In an area where the temperature may fall below 40°F or rise above 100°F, such as garages and unfinished attics.
- In dusty areas. Dust particles may cause nuisance alarms or a failure to alarm.
- In very humid areas (above 95% RH, non-condensing) as moisture or steam can cause nuisance alarms.
- In insect-infested areas.
- Smoke alarms should not be installed within 3 ft (0.9m) of the door to a bathroom containing a tub or shower, forced air supply ducts used for heating or cooling, ceiling or whole house ventilating fans, or other high air flow areas.
- Near lights. Electronic "noise" generated by the lights may cause nuisance alarms.
- Do not install near vents, flues, or chimneys.
- Do not install near fans, doors, windows or areas directly exposed to the weather.
- Avoid installing where the unit will be exposed to direct sunlight.

9. Wiring / Installation / Activation

NOTE: A dust cover has been installed on the alarm. Keep the dust cover on until all construction has been completed for at least 24 hours (drywall, painting, varnishing, mounting plate install, etc). Retain the dust cover and re-install it to protect the alarm during future construction projects. Construction dust and chemicals can cause contamination and false alarms.



Figure 9-A

⚠ WARNING: DUST COVER MUST BE REMOVED FOR ALARM TO OPERATE.

NOTE: To avoid false low battery chirping pull out the battery pull tab first to activate the backup batteries (see Figure 9-A). Battery activation is confirmed with a beep. If the beep does not occur when the battery pull tab is removed, remove the batteries and reinstall them. Confirm the battery activation beep.

Wiring Requirements

- This alarm should be installed on a UL Listed or recognized junction box. All connections should be made by a qualified electrician and all wiring used shall be in accordance with articles 210 and 300.3(B) of the U.S. National Electrical Code ANSI/NFPA 70, NFPA 72 and/or any other codes having jurisdiction in your area. The multiple station interconnect wiring to the alarms must be run in the same raceway or cable as the AC power wiring. In addition, the resistance of the interconnect wiring shall be a maximum of 10 ohms.
- The maximum wire run distance between the first and last unit in an interconnected system is 1000 feet.
- The appropriate power source is 120 Volt AC Single Phase supplied from a non-switchable circuit.
- Smoke alarms are not to be used with detector guards unless the combination (alarm and detector guard) has been evaluated and found suitable for that purpose.
- Kidde alarms are not designed, agency tested or certified for recessed mounting and should not be installed in this manner. Recessed mounting impedes smoke entry into the smoke chamber, which may prevent the alarm from sounding in a timely manner. This could endanger the lives of occupants in the residence. Kidde alarms are designed, tested and certified for wall (if applicable) and ceiling surface mount only.

⚠ WARNING: THE ALARM CANNOT BE OPERATED FROM POWER DERIVED FROM A SQUARE WAVE, MODIFIED SQUARE WAVE OR MODIFIED SINE WAVE, INVERTER. THESE TYPES OF INVERTERS ARE SOMETIMES USED TO SUPPLY POWER TO THE STRUCTURE IN OFF GRID INSTALLATIONS, SUCH AS SOLAR OR WIND DERIVED POWER SOURCES. THESE POWER SOURCES PRODUCE HIGH PEAK VOLTAGES THAT WILL DAMAGE THE ALARM.

Wiring Instructions for AC Quick Connector Harness

⚠ CAUTION: Turn off the main power to the circuit before wiring the alarm.

- For alarms that are used as single station, DO NOT CONNECT THE RED WIRE TO ANYTHING. Leave the red wire insulating cap in place to make certain that the red wire cannot contact any metal parts or the electrical box.
- When alarms are hardwire interconnected, all interconnected units must be powered from a single circuit.
- A maximum of 24 Kidde Safety devices may be interconnected in a multiple station arrangement. The interconnect system should not exceed the NFPA interconnect limit of 12 smoke alarms and/or 18 alarms total (smoke, CO, Smoke/ CO Combination, heat, etc.). With 18 alarms interconnected, it is still possible to interconnect up to a total of 6 remote signaling devices and/or relay modules.
- Figure 9-B illustrates interconnection wiring. Improper connection will result in damage to the alarm, failure to operate, or a shock hazard.
- Make certain alarms are wired to a continuous (non-switched) power line.

FUSE OR CIRCUIT BREAKER

Figure 9-B, Interconnect Wiring Diagram

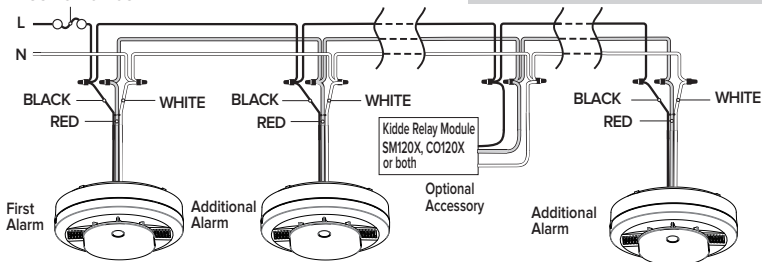

Wires on alarm harness: Connected to:
Black: Hot side of AC line
White: Neutral side of AC line
Red: Interconnect lines (red wires) of other units in the multiple station set-up

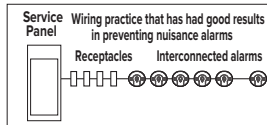

Figure 9-C

NOTE: Use standard UL Listed household wire (as required by local codes) available at all electrical supply stores and most hardware stores.

NOTE: AC power should be turned off at this stage.

- For best results to minimize nuisance alarms, interconnected alarms should be on a dedicated line. If not on a dedicated line, it is suggested that the smoke alarms share a lighting load circuit that does not have a dimmer associated with it. If receptacles must be placed on the same line it is suggested that they be placed ahead of the smoke alarms (see Figure 9-C). This will prevent large voltage drops from occurring between the first and last alarm in the circuit.
- After selecting the proper location for your alarm, and wiring the AC QUICK CONNECTOR harness as described previously, attach the mounting bracket to the electrical box. To ensure aesthetic alignment of the alarm with the hallway, or wall, the "A" line on the mounting bracket should be parallel with the hallway when ceiling mounted, or horizontal when wall mounted. (See Figure 9-D)
- Pull the AC QUICK CONNECTOR through the center hole in the mounting bracket and secure the bracket, making sure that the mounting screws are positioned in the small ends of the keyholes before tightening of the screws.
- Plug the AC QUICK CONNECTOR into the back of the unit, making sure that the connector snaps into place. Then push the excess wire back into the electrical box through the hole in the center of the mounting bracket.

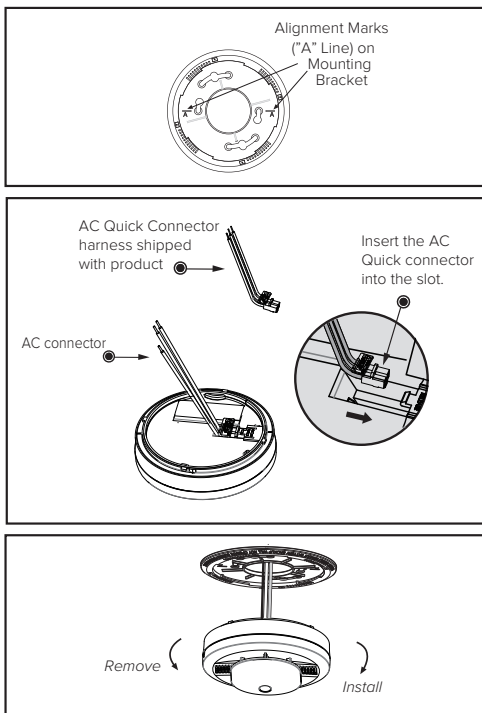

Figure 9-D

Then push the excess wire back into the electrical box through the hole in the center of the mounting bracket.

NOTE: Do not grab the shield to install or remove the alarm. Grab the alarm by the outside of the enclosure. (Figure 9-E).

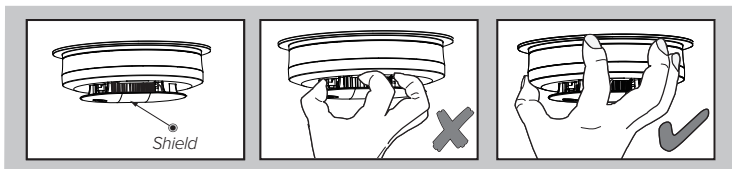

Figure 9-E

NOTE: If either battery is missing, the alarm cannot mount on the mounting bracket.

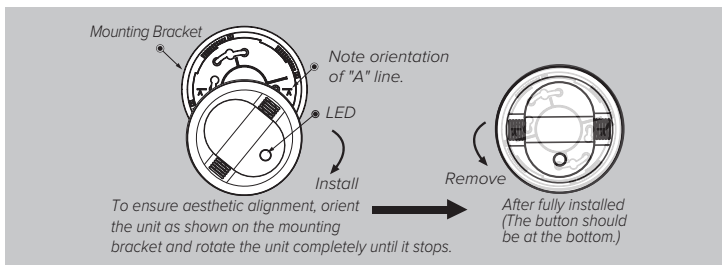

Figure 9-F

- Install the alarm fully on the mounting bracket by rotating the alarm in a clockwise direction (Figure 9-F).

NOTE: The alarm will mount to the bracket in 4 positions (every 90 degrees).

- Turn on the AC power. The green AC Power On Indicator should be lit when the alarm is operating from AC power.

NOTE: Attaching AC power first, without removing the battery pull tab, will result in a false low battery trouble condition chirp (see Troubleshooting Guide). You need to activate the batteries to eliminate the false low battery trouble condition chirps. Remove the battery pull tab to avoid false low battery notification.

AC Wired Interconnect Model Capability

This model has AC hardwire interconnect capability. When one hardwired interconnect unit sounds an alarm, all other compatible hardwire or interconnected units will also alarm. **NOTE:** AC wiring must be completed properly and the AC quick connector must be attached to the unit for the hardwire interconnect function to work.

The following models can be interconnected using the standard AC wiring interconnect: i12020, i12020A, i12040, i12040A, i12060, i12060A, i12080, i12080A, i4618A, i4618AC, KN-SMFM-I, RF-SM-ACDC, PE120, P12040, Pi2000, Pi2010, KN-COSM-I, KN-COSM-IB, KN-COSM-IBA, KN-COPE-I, KN-COB-IC, SL177i, SLED177i, HD135F, SM120X, CO120X, i12010S, i12010SCO, P4010ACSCO, P4010ACSCO-W, P4010LACS-W, P4010ACS, P4010ACS-W, P4010ACLEDS, P4010ACLEDS-2, P4010ACLEDSCO, P4010ACLEDSCO-2, 3050-VAS10-A, 3050-VASC10-A, P4010ACS-WF, P4010ACSAQ-WF, P4010ACSCO-WF, P4010ACSCOAQ-WF, 900-CUAR, 900-CUAR-V, 20SAR, 20SA10, 20SA10-V, 30CUAR, 30CUAR-V, 30CUA10, 30CUA10-V.

The alarm is now activated! After installation/activation, test your alarm as described in Operation and Testing section.

⚠ WARNING: Failure to properly connect AC power and install batteries in the correct orientation will prevent proper operation of this alarm and will prevent its response to fire and CO hazards.

10. Operation And Testing

This model meets the latest residential smoke alarm standards, which includes enhanced resistance to nuisance alarms from cooking.

Operation

The alarm is operating once it is activated and testing is complete (see “TESTING” below). When products of combustion (smoke or CO) are sensed, the unit sounds a loud alarm. See Sections 1 and 2 for alarm signal descriptions. In high levels of CO, the unit will go into alarm in a shorter period of time than at low levels of CO.

Testing

⚠ WARNING: Do not attempt to test this unit with retail “canned smoke” products. Those products are intended for use by trained professionals and produce inconsistent results when misused. Over-application of canned smoke can permanently damage the alarm.

SELF-TESTING

This model is equipped with internal, self-testing components that are always checking to ensure the device is operating as expected. (Weekly manual testing is still required. See below.)

MANUAL TESTING

NOTE: When pushing the Test button, use only your finger or thumb. Using any other instrument(s) (such as a broom handle) is strictly prohibited, as it may damage the alarm.

Test your alarm weekly by pressing and releasing the button quickly. A quick beep will confirm the button has been pushed followed by the test sequence. See Other Alarm Visual and Audible Indicators table. The alarm (and any interconnected units) will sound if the electronic circuitry, horn, and batteries are working. If the alarm does not sound, or gives erratic or low volume sound, the unit must be replaced.

⚠ WARNING: DUE TO THE LOUDNESS OF THE ALARM, ALWAYS STAND ABOUT 2.5 FEET AWAY FROM THE UNIT OR USE EAR PROTECTION WHEN TESTING.

⚠ WARNING: DO NOT USE AN OPEN FLAME TO TEST YOUR ALARM, YOU COULD DAMAGE THE ALARM OR IGNITE COMBUSTIBLE MATERIALS AND START A STRUCTURE FIRE.

Chirping

When End of Unit Life or Low Battery chirping begins, you can temporarily silence these chirps by pressing the button. Other fault/error chirps cannot be silenced. Take appropriate action as described in the Troubleshooting Guide.

⚠ WARNING: REPLACE UNIT AS SOON AS POSSIBLE WHEN IN END OF UNIT LIFE. SEVEN (7) DAYS AFTER END OF UNIT LIFE BEGINS, THE NOTIFICATIONS CANNOT BE SILENCED, AND SMOKE AND CO DETECTION CANNOT BE GUARANTEED. REPLACE IMMEDIATELY!

CO ALARM SENSOR RESPONSE TIMES

At 70 PPM, the unit must alarm within 60-240 minutes.

At 150 PPM, the unit must alarm within 10-50 minutes.

At 400 PPM, the unit must alarm within 4-15 minutes.

11. Recognizing Nuisance Alarms

Smoke Nuisance

This model meets the latest residential smoke alarm standards, which includes enhanced resistance to nuisance alarms from cooking.

HUSH™: If you know why the alarm is sounding, and you can verify that it is not a life threatening situation, you can push the button on the initiating unit to silence the alarm for 8-10 minutes. If the smoke is not too dense, that unit, and all interconnected units will silence. After the Hush™ period, the smoke alarm will automatically reset and sound the alarm if particles of combustion are still present. You can use Hush™ repeatedly until the air has been cleared of the condition causing the alarm.

NOTE: Dense smoke will override Hush™ and sound a continuous alarm. If no fire is present, check to see if one of the reasons listed in “Locations to avoid” may have caused the alarm. If a fire is discovered, get out and call the fire department or 911.

Cigarette smoke will not normally cause the unit to alarm, unless the smoke is blown directly into the alarm. Combustion particles from cooking may set off the alarm if it is located too close to a cooking appliance. Large quantities of combustible particles are generated from spills or when broiling. Using the fan on a range hood which vents to the outside (non-recirculating type) will also help prevent nuisance alarms from occurring by removing these combustible products from the kitchen.

Carbon Monoxide (CO) Nuisance

RESET: Pushing the button during CO alarm allows the unit to reset calculations and double check for the presence of CO. If the unit re-alarms within 6 minutes, it is sensing high levels of CO which can quickly become a dangerous situation. Move to fresh air and call 911.

⚠ WARNING: IT IS IMPOSSIBLE TO DETERMINE THE SOURCE OF A CO ALARM USING SIGHT OR SMELL. ALWAYS CONSIDER A CO ALARM EVENT AS DANGEROUS.

12. Battery Backup

This alarm is powered with AC power, but also contains two replaceable AA backup batteries. Under normal conditions, fresh batteries will last at least one year.

In order to access the battery compartment, the wiring harness needs to be removed. To release the wiring harness, press down on the tab as shown in Figure 12-A.

NOTE: Constant exposure to high or low humidity or temperatures may reduce battery life.

⚠ WARNING: THE ALARM IS SEALED AND THE COVER IS NOT REMOVABLE.

LOW BATTERY

This alarm is equipped with a low battery monitor circuit. If the battery capacity is nearing the point where it can no longer provide adequate power for all alarm functions, the low battery condition will occur. See Troubleshooting Guide. The batteries must be replaced within 7 days of the first occurrence of the “Low Battery Warning” to provide continuous alarm detection.

Replace batteries with one of the following approved brands:

Energizer E91, Gold Peak 15A or Golden Power GLR6A.

These batteries can be purchased at your local retailer.

⚠ WARNING: Use only the batteries specified. Use of different batteries may have a detrimental effect on the alarm. Do not mix old and new batteries. Do not mix alkaline, standard, or rechargeable batteries.

NOTE: Do not use lithium batteries in this unit. A good safety measure is to replace the batteries at least once a year, or at the same time you change your clocks for daylight saving time. Loss of AC power and a missing or improperly installed battery will render the unit inoperable.

⚠ WARNING: FAILURE TO PROPERLY CONNECT AC POWER AND INSTALL BATTERIES IN THE CORRECT ORIENTATION WILL PREVENT PROPER OPERATION OF THIS ALARM AND WILL PREVENT ITS RESPONSE TO FIRE AND CO HAZARDS.

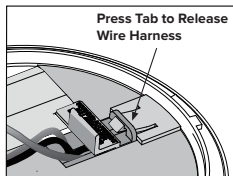

Figure 12-A

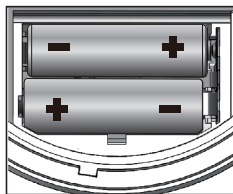

Figure 12-B

13. General Carbon Monoxide (CO) Information

Carbon monoxide (CO) is a colorless, odorless, and tasteless poison gas that can be fatal when inhaled. CO inhibits the blood's capacity to carry oxygen.

Possible Sources of CO

Inside your home, appliances used for heating and cooking are the most likely sources of CO. Vehicles and other combustion engines running in an attached garage and using a charcoal/gas grill or hibachi in an enclosed area are all possible sources of CO. Generators running in enclosed areas, such as garages or living spaces, will create CO. CO can be produced when burning any fossil fuel: gasoline, diesel, propane, natural gas, oil and wood. It can be produced by any fuel-burning appliance that is malfunctioning, improperly installed, or not ventilated correctly, such as: Furnaces/boilers, gas ranges/stoves, gas clothes dryers, water heaters, portable fuel burning space heaters, fireplaces, wood-burning stoves and certain swimming pool heaters. Blocked chimneys or flues, back drafting and changes in air pressure, corroded or disconnected vent pipes, or a loose or cracked furnace heat exchanger can also release CO into your building.

The following conditions can result in transient CO situations:

Excessive spillage or reverse venting of fuel-burning appliances caused by outdoor ambient conditions such as: Wind direction and/or velocity, including high gusts of wind, heavy air in the vent pipes (cold/humid air with extended periods between cycles), negative pressure differential resulting from the use of exhaust fans, simultaneous operation of several fuel-burning appliances competing for limited internal air, vent pipe connections vibrating loose from clothes dryers, furnaces/boilers, or water heaters, obstructions in, or unconventional, vent pipe designs which can amplify the above situations, extended operation of unvented fuel-burning devices (range, oven, fireplace, etc.), temperature inversions which can trap exhaust gases near the ground, car idling in an open or closed attached garage, or near a home.

CO Safety Tips

Every year, have the heating system, vents, chimney and flue inspected and cleaned by a qualified technician. Always install appliances according to manufacturer's instructions and adhere to local building codes. Most appliances should be installed by professionals and inspected after installation.

Regularly examine vents and chimneys for improper connections, visible rust, or stains, and check for cracks in furnace heat exchangers. Verify that the color of flame is blue on pilot lights and burners. An amber or orange flame is a sign that the fuel is not burning completely and may be releasing CO. Teach all household members what the alarm sounds like and how to respond. Fire Departments, most utility companies and HVAC contractors will perform CO inspections. Some contractors may charge for this service. It's advisable to inquire about any applicable fees prior to having the service performed. Kidde will not pay for, or reimburse the owner or user of this product, for any repair or dispatch calls related to the alarm sounding.

Symptoms of CO Poisoning

Initial carbon monoxide poisoning symptoms are similar to the flu with no fever and can include dizziness, severe headaches, nausea, vomiting and disorientation. Everyone is susceptible but experts agree that unborn babies, pregnant women, senior citizens and people with heart or respiratory problems are especially vulnerable. If symptoms of carbon monoxide poisoning are experienced seek medical attention immediately. CO poisoning can be determined by a carboxyhemoglobin test.

The following symptoms are related to CARBON MONOXIDE POISONING and should be discussed with ALL members of the household:

- 1. MILD EXPOSURE:** Slight headache, nausea, vomiting, fatigue (often described as “Flu-like” symptoms).
- 2. MEDIUM EXPOSURE:** Severe throbbing headache, drowsiness, confusion, fast heart rate.
- 3. EXTREME EXPOSURE:** Unconsciousness, convulsions, cardio respiratory failure and death.

The above levels of exposure relate to healthy adults. Levels differ for those at high risk. Exposure to high levels of carbon monoxide can be fatal or cause permanent damage and disabilities. Many cases of reported carbon monoxide poisoning indicate that while victims are aware they are not feeling well, they become so disoriented they are unable to save themselves by either exiting the building, or calling for assistance. Also, young children and household pets may be the first affected. Familiarization with the effects of each level is important.

14. Cleaning Your Alarm

Your Alarm Should be Cleaned at Least Once a Year

You can clean the interior of your alarm (sensing chamber) by using compressed air or a vacuum cleaner hose and blowing or vacuuming through the openings around the perimeter of the alarm. The outside of the alarm can be wiped with a damp cloth. Use only water to dampen the cloth, use of detergents or cleaners could damage the alarm.

NOTE: Do not insert fingers or cleaning items under the shield during cleaning.

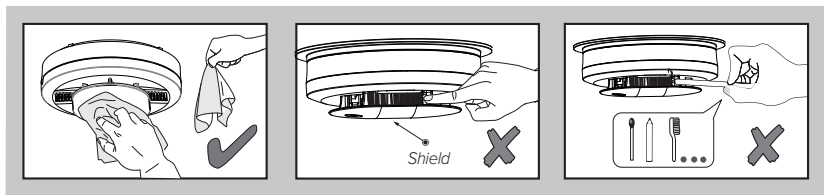

Figure 14-A

If the alarm is in Fault mode, the alarm may be in need of cleaning. After cleaning, press the button. If the fault does not clear, the alarm needs to be replaced.

- Never use detergent or other solvents to clean the unit.
- Avoid spraying air freshener, hair spray, or other aerosols near the alarm.
- Do not use a hair dryer to clean the alarm, as it may damage the alarm and impact performance.
- Do not paint the unit. Paint will seal the vents and interfere with the sensor's ability to detect smoke and CO.
- Never attempt to disassemble the unit to clean inside. This action will void your warranty.
- The following substances can affect the CO sensor and may cause false readings and damage to the sensor: Methane, propane, isobutane, iso-propanol, ethyl acetate, hydrogen sulfide, sulfide dioxides, alcohol based products, paints, thinner, solvents, adhesives, hair spray, aftershave, perfume, and some cleaning agents.

- Move the Alarm and place in another location prior to performing any of the following:
 - Staining or stripping wood floors or furniture
 - Painting
 - Wall papering
 - Using adhesives

Storing the unit in a plastic bag during any of the above projects will protect the sensors from damage. When household cleaning supplies or similar contaminants are used, the area must be well ventilated.

⚠ WARNING: REINSTALL THE ALARM AS SOON AS POSSIBLE TO ENSURE CONTINUOUS DETECTION.

15. Good Safety Habits

Develop and Practice a Plan of Escape

Prepare and practice a home escape plan twice a year, including drills at night. Know two ways out of every room (door & window) and identify a meeting place outside the home where everyone will gather once they have exited the residence. When two people have reached the meeting place, one should leave to call 911 while the second person stays to account for additional family members.

Establish a rule that once you're out, you never re-enter under any circumstance!

- Make a floor plan indicating all doors and windows and at least two (2) escape routes from each room. Stories above ground level may need a rope or chain ladder.
- Have a family meeting and discuss your escape plan, showing everyone what to do in case of fire and where to meet after they leave the house.
- Ensure that small children hear the alarm and wake when it sounds. They must wake up in order to execute the escape plan. Practice allows all occupants to test your plan before an emergency. You may not be able to reach your children. It is important they know what to do.
- Familiarize everyone with the sounds of the smoke/CO alarm and train them to leave your home when they hear it.
- Current studies have shown smoke/CO alarms may not awaken all sleeping individuals, and that it is the responsibility of individuals in the household that are capable of assisting others to provide assistance to those who may not be awakened by the alarm sound, or to those who may be incapable of safely evacuating the area unassisted.
- Install and maintain fire extinguishers on every level of the home and in the kitchen, basement and garage. Know how to use a fire extinguisher prior to an emergency.

Fire Prevention

Never smoke in bed or leave cooking food unattended. Teach children never to play with matches or lighters! Train everyone in the home to recognize the smoke alarm pattern and to leave the home using their escape plan when it's heard. Know how to do "Stop, Drop and Roll" if clothes catch on fire, and how to crawl low under smoke. Install and maintain fire extinguishers on every level of the home and in the kitchen, basement and garage.

NFPA (National Fire Protection Association)

Fire Safety in the Home: NFPA 72 is intended to provide reasonable safety for persons in family living units. Reasonable fire safety can be produced through the following three-point program:

(1) Minimizing fire hazards (2) Providing fire-warning equipment (3) Having and practicing an escape plan.

Smoke Detection – Are More Alarms Desirable?

The required number of smoke alarms might not provide reliable early warning protection for those areas separated by a door from the areas protected by the required smoke alarms. For this reason, it is recommended that the resident consider the use of additional smoke alarms for those areas for increased protection. The additional areas include the basement, bedrooms, dining room, furnace room, utility room, and hallways not protected by the required smoke alarms. The installation of smoke alarms in attics (finished or unfinished), garages, or within 6' of a heating or cooking appliance is not normally recommended, as these locations occasionally experience conditions that can result in improper operation. *

* Reference National Fire Protection Association (NFPA) standard 72

For your information, the National Fire Protection Association's Standard 72 reads: Where required by other governing laws, codes, or standards for a specific type of occupancy, approved single and multiple-station smoke alarms shall be installed as follows:

1. In all sleeping rooms and guest rooms
2. Outside of each separate dwelling unit sleeping area, within 21 ft (6.4 m) of any door to a sleeping room, with the distance measured along a path of travel
3. On every level of a dwelling unit, including basements
4. On every level of a residential board and care occupancy (small facility), including basements and excluding crawl spaces and unfinished attics
5. In the living area(s) of a guest suite
6. In the living area(s) of a residential board and care occupancy (small facility)

California State Fire Marshal

Early warning fire detection is best achieved by the installation of fire detection equipment in all rooms and areas of the household as follows: A smoke alarm installed in each separate sleeping area (in the vicinity, but outside the bedrooms), heat or smoke detectors in the living rooms, dining rooms, bedrooms, kitchens, hallways, attics, furnace rooms, closets, utility and storage rooms, basements and attached garages.

FCC

This device complies with part 15 of the FCC Rules. Operation is subject to the following two conditions: (1) This device may not cause harmful interference, and (2) this device must accept any interference received, including interference that may cause undesired operation.

⚠ WARNING! Changes or modifications not expressly approved by the party responsible for compliance could void the user's authority to operate this device.

NOTE: This equipment has been tested and found to comply with the limits for a Class B digital device, pursuant to part 15 of the FCC Rules. These limits are designed to provide reasonable protection against harmful interference in a residential installation. This equipment generates, uses, and can radiate radio frequency energy and, if not installed and used in accordance with the instructions, may cause harmful interference to radio communications.

However, there is no guarantee that interference will not occur in a particular installation. If this equipment does cause harmful interference to radio or television reception, which can be determined by turning the equipment off and on, the user is encouraged to try to correct the interference by one or more of the following measures:

- Reorient or relocate the receiving antenna.
- Increase the separation between the equipment and receiver.
- Connect the equipment into an outlet on a circuit different from that to which the receiver is connected.
- Consult the dealer or an experienced radio/TV technician for help.

16. Service And Warranty

Ten-Year Limited Warranty

Kidde warrants that the enclosed alarm will be free from defects in material and workmanship or design under normal use and service for a period of ten years from the date of purchase.

The obligation of Kidde under this warranty is limited to repairing or replacing the alarm or any part which we find to be defective in material, workmanship or design (part replacement only, no installation), free of charge, upon receiving the alarm with proof of date of purchase, postage and return postage prepaid, to Warranty Service Department, Kidde, 1016 Corporate Park Drive, Mebane, NC 27302. Before shipping the product, please remove the batteries from the battery compartment.

This warranty shall not apply to the alarm if it has been damaged, modified, abused or altered after the date of purchase or if it fails to operate due to improper maintenance or inadequate power. Any implied warranties arising out of this sale, including but not limited to the implied warranties of description, merchantability and fitness for a particular purpose, are limited in duration to the above warranty period. In no event shall the Manufacturer be liable for loss of use of this product or for any indirect, special, incidental or consequential damages, or costs, or expenses incurred by the consumer or any other user of this product, whether due to a breach of contract, negligence, strict liability in tort or otherwise.

The Manufacturer shall have no liability for any personal injury, property damage or any special, incidental, contingent or consequential damage of any kind resulting from gas leakage, smoke, fire or explosion. Since some states do not allow limitations of the duration of an implied warranty or do not allow the exclusion or limitation of incidental or consequential damages, the above limitations or exclusions may not apply to you. While this warranty gives you specific legal rights, you may also have other rights which vary from state to state.

The above warranty may not be altered except in writing signed by both parties hereto. Your Kidde Alarm is not a substitute for property, fire, disability, life or other insurance of any kind. Appropriate insurance coverage is your responsibility. Consult your insurance agent. Opening the unit will void the warranty. If there are any differences between this printed warranty and the online limited warranty, then the terms of the online warranty supersede those in this user guide or other printed materials. Visit www.kidde.com for the latest warranty statement.



QUESTIONS OR FOR MORE INFORMATION

Call Kidde Product Support line at **1-800-880-6788**
or contact us at www.kidde.com

Kidde

1016 Corporate Park Drive, Mebane, NC 27302

©2024 Kidde. All Rights Reserved.