

# INSTRUCTIONS

## STL110H/L, STL110HB/L, STL110R/L INSTALLATION

# RAB®

RAB Lighting is committed to creating high-quality, affordable, well-designed and energy-efficient LED lighting and controls that make it easy for electricians to install and end users to save energy. We'd love to hear your comments. Please call the Marketing Department at 888-RAB-1000 or email: [marketing@rablighting.com](mailto:marketing@rablighting.com)



STL110H/L



STL110HB/L



STL110R/L

### IMPORTANT

#### READ CAREFULLY BEFORE INSTALLING FIXTURE. RETAIN THESE INSTRUCTIONS FOR FUTURE REFERENCE.

RAB fixtures must be wired in accordance with the National Electrical Code and all applicable local codes. Proper grounding is required for safety. THIS PRODUCT MUST BE INSTALLED IN ACCORDANCE WITH THE APPLICABLE INSTALLATION CODE BY A PERSON FAMILIAR WITH THE CONSTRUCTION AND OPERATION OF THE PRODUCT AND THE HAZARDS INVOLVED.

**WARNING: Make certain power is OFF before installing or maintaining fixture. No user serviceable parts inside.**

**CAUTION: TURN OFF ALL POWER AT CIRCUIT BREAKER/FUSE PANEL. The total lighting load connected to Stealth must not exceed 8 amps 120-277V (LED load). To switch more wattage an electrician can install a relay. Line Carrier Remote Control Systems such as X-10 or Leviton are incompatible with sensors and cause false activations.**

**DO NOT INSTALL SENSORS ON A CIRCUIT THAT FEEDS MOTOR LOADS LIKE KITCHEN APPLIANCES, HVAC EQUIPMENT, WASHER/DRYER, OR GARAGE DOOR OPENERS. Sensor must be below and as far as possible away from lights. Sensor functions best when the direction of expected movement is across its detection pattern, not towards the sensor. Mount 6–12 feet high for optimum range and detection.**

## MOUNTING

STL110 floodlight apps come pre-wired and assembled on the RAB CU4 EZ Plate, allowing for mounting on round, rectangular or octagonal surface or recessed boxes as shown in Fig. 1.

## SETTINGS

Stealth's infrared sensor "sees" small temperature changes caused by the motion of people or cars within its protection zone and turns on lights automatically. It welcomes visitors and may deter intruders.

**How long do the lights stay on?** Lights remain on as long as there is movement within the protection zone. Once the zone is vacated lights can be adjusted to remain on approximately 5 seconds up to 12 minutes. Since the lights are on only when needed and the sensor uses only one watt the Stealth is extremely energy efficient.

**Can outdoor lights still be turned on with the light switch?** Yes. Stealth can be controlled by a conventional indoor switch or circuit breaker. Lights can be turned on or off manually at night only.

**Manual Override Mode:** (to keep lights on) Flip the switch twice slowly (off-on-off-on) within 2–3 seconds.

**To Resume Automatic Mode:** Flip the switch once (off-on) within 2 seconds. Sensor will reset to Automatic Mode.

Fig: 1

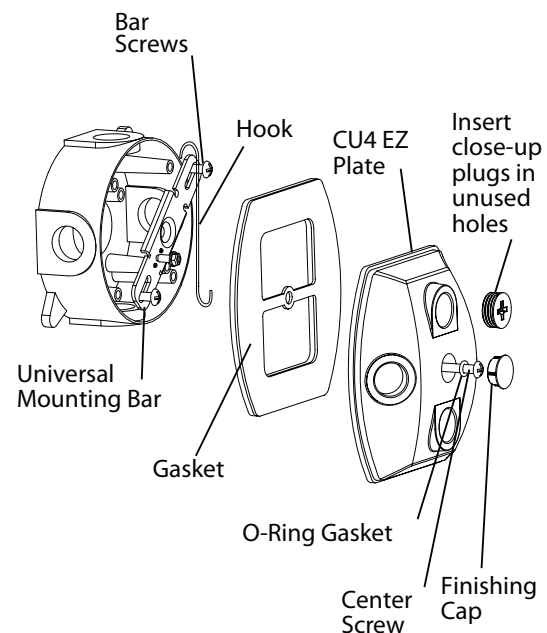

# INSTRUCTIONS

## STL110H/L, STL110HB/L, STL110R/L INSTALLATION



RAB Lighting is committed to creating high-quality, affordable, well-designed and energy-efficient LED lighting and controls that make it easy for electricians to install and end users to save energy. We'd love to hear your comments. Please call the Marketing Department at 888-RAB-1000 or email: [marketing@rablighting.com](mailto:marketing@rablighting.com)

### SETTINGS (cont'd)

**Will Stealth detect animals?** Stealth may detect large animals. Having animals trigger the sensor can give property a "lived-in" look. However, you can limit animal detection by turning down the sensitivity knob.

#### How are the Time, Sensitivity and Photocell adjusted? Fig 2

**Time:** Sets the time that lights will remain on after the detection zone is vacated from approximately 5 seconds to 12 minutes. Factory Setting: 5–8 minutes

**Sensitivity:** Increases or decreases the responsiveness and range of the sensor (Adjusts from 30% to 100%) Factory Setting: 100%

**Photocell:** Located behind the lens. For night only operation, turn the knob all the way clockwise to (to the moon symbol). For 24 hour operation turn the knob all the way counterclockwise (sun & moon). Adjust clockwise to have the sensor come on later at dusk, counter-clockwise to have it come on earlier. Factory Setting: Night Only.

Fig. 2

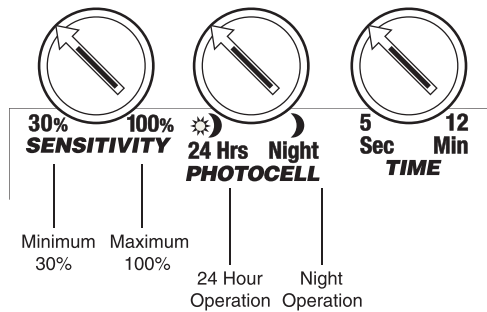

### CHOOSING A LOCATION

Choose a location from which the sensor can "see" all the paths of movement. The sensor may be wall or ceiling mounted.

As distance from the sensor increases, it will take more movement to be detected. For instance, at 10 feet, a half step will be enough, while at 40 feet several steps will be necessary.

**How large an area does Stealth detect?** The standard lens detection pattern extends out 50 feet and is 110° wide. The sensor may be swiveled in any direction to cover the area desired. Always keep the sensor level to insure full coverage. To reduce coverage tilt the sensor down.

Stealth STL110 comes with a standard "Double Look Down" Lens. This lens has one "Look Out" zone and two "Look Down" zones, for excellent detection both at long and close range. (Fig 4)

The Long Range model STL110LRL provides a long, narrow protection zone for alleys and along buildings.

### HOW DOES THE LED DETECTION INDICATOR WORK?

The red LED above the lens shows the logic state of the sensor. If the sensor is set for night only operation, the LED will go on for daytime detections without turning on the lights (Fig 3). At night, the LED will be on all the time, except during detections (at which time the controlled lights will go on). At night, the LED serves as a deterrent indicating a security device in operation.

Fig. 3

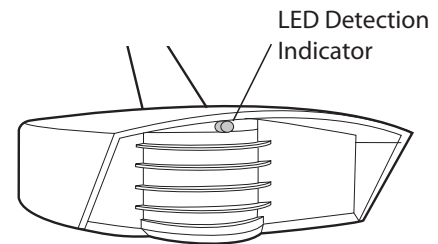
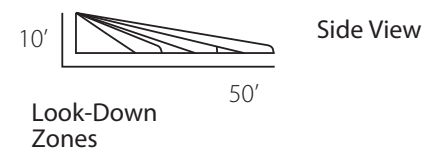
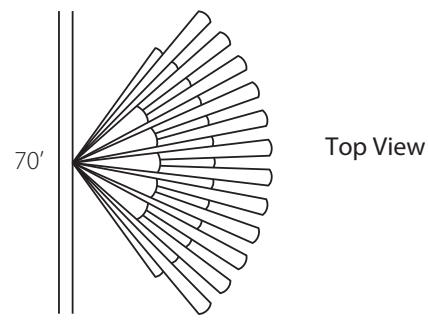
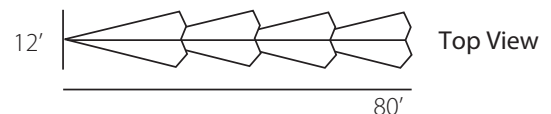

Fig. 4



#### Long Range Model



# INSTRUCTIONS

## STL110H/L, STL110HB/L, STL110R/L INSTALLATION

# RAB®

RAB Lighting is committed to creating high-quality, affordable, well-designed and energy-efficient LED lighting and controls that make it easy for electricians to install and end users to save energy. We'd love to hear your comments. Please call the Marketing Department at 888-RAB-1000 or email: [marketing@rablighting.com](mailto:marketing@rablighting.com)

### WIRING

1. Attach the **Universal Mounting Bar** with the **Bar Screws** (provided) to the junction box as shown in **Fig 5**. If you are attaching your STL110 kit to a surface mount weatherproof box, you must use the metal plate with the attached gasket. The gasket faces the Junction Box.
2. Easy Wiring Tip: Use the "S" shaped **Hands Free Hanging Hook** to hold the **EZ Plate** during wiring.
3. Bring power leads and sensor kit leads through holes in all gaskets into junction box.
4. Strip 1/2" of insulation from all leads.
5. Attach ground wire(s) to junction box grounding screw. Connect as shown in **Fig 6**.
6. Twist on wire nuts. Secure with electrical tape.
7. Align **EZ Plate** and metal mounting plate to insure proper seal. Tighten **EZ Plate** center screw (make sure **O-Ring Gasket** is on the screw) to attach **EZ Plate** to the box. There are 2 screws supplied. Use the one which suits your assembly best.
8. Insert plastic **Finishing Cap** in the center of the **EZ Plate** for a weatherproof seal.
9. Use silicone sealant around all openings to insure a weatherproof seal.
10. Screw in lamps (if not already installed). Turn on power. Conduct walk test to adjust sensor response.

Fig. 5

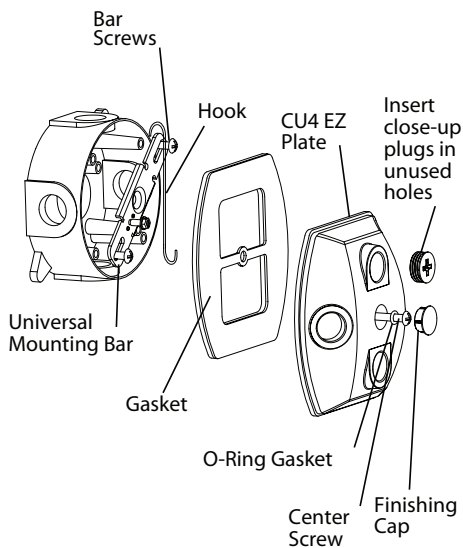

### WIRING

Fig. 6

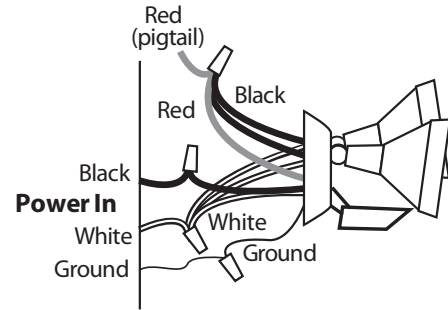

*Red pigtail is only used to switch remote or additional fixtures.*

### SWITCHPLATE LABEL

Switchplate label with self-adhesive backing (**Fig 7**).

Attach Stealth operating instruction label to switchplate for quick and easy reference.

Fig. 7

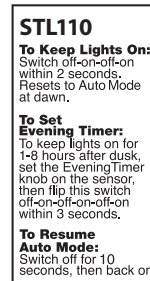

**Note:** These instructions do not cover all details or variations in equipment nor do they provide for every possible situation during installation, operation or maintenance.

# INSTRUCTIONS

## STL110H/L, STL110HB/L, STL110R/L INSTALLATION

# RAB®

RAB Lighting is committed to creating high-quality, affordable, well-designed and energy-efficient LED lighting and controls that make it easy for electricians to install and end users to save energy. We'd love to hear your comments. Please call the Marketing Department at 888-RAB-1000 or email: [marketing@rablighting.com](mailto:marketing@rablighting.com)

### AIMING AND WALK TESTING

**Walk Test.** The purpose of the Walk Test is to check and adjust the coverage pattern. Stealth has a 5 minute Test Period which allows the sensor to be aimed and walk tested day or night. If you require 5 more minutes of Test Time, turn the power off for at least 10 seconds and back on again. During the Test Period, the sensor will keep lights on for 5 seconds each time it detects movement in its Detection Zone. The sensor will change to Automatic Mode after 5 minutes of testing.

**To enter Test Mode:** Turn power off for at least 10 seconds and back on.

1. Aim the sensor across the traffic pattern you want to detect. Start by aiming the sensor downward and then raise it slowly until the desired range is obtained.
2. Start outside the pattern and walk across the pattern as shown in **Fig 8** until the lights go on. As distance from the sensor increases, it will take more movement to be detected.
3. Adjust the sensor aiming as necessary to improve coverage.
4. To adjust the sensitivity turn knob gently. Less sensitivity (counter-clockwise) may be desired if you wish to detect a limited area or if the sensor is being activated by wind, foliage or animals. More sensitivity (clockwise) will help cover a larger area.

Fig. 8

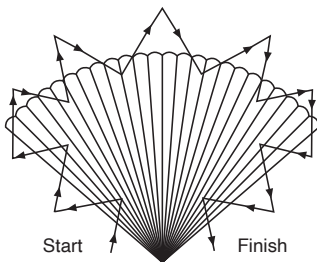

5. Repeat steps #2 thru #4 until you are satisfied with the coverage.
6. The "Time" control is factory set at approximately 5–8 minutes. This period starts after the movement in the detection pattern ceases. If less time is desired, turn the time control counter-clockwise. For more time, turn the knob clockwise. (**Fig 9**)
7. Stealth is factory set for night only operation. To obtain 24 hour operation, turn the photocell control full counter-clockwise. Intermediate settings will adjust operation during dusk and dawn.
8. Your sensor is ready for operation. See the Technical Tips if additional help is needed.

Fig. 9

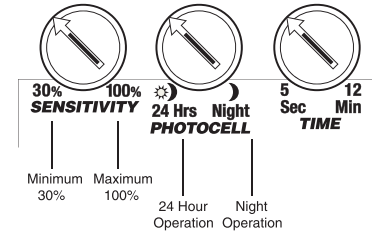

### TECHNICAL TIPS

#### Lights Do Not Turn Off

1. Make sure that the sensor is not in Manual Override Mode. Turn power OFF for 10 seconds, then ON Sensor will be in Test Mode for approximately 5 minutes, then it will switch to Auto Mode with lights off and ready to detect movement.
2. Make sure sensor is not aimed at or mounted over something that would move or change temperature such as waving branches, water, air conditioners, windows or heating vents—even on neighboring property. You can test for infrared sources in the area by placing a box or bag over the sensor. Put sensor into test mode. Lights should stay off. Wave your hand inside bag in front of sensor. Lights should go on and then time out. If sensor operates properly when covered, check items #4–7
3. Make sure sensor and lights are mounted firmly and do not move even slightly when touched. If they move, tighten all screws.
4. Make sure sensor is not mounted on an unstable object such as a tree or pole that will move in the wind.
5. Was sensor wired hot? If so, circuitry may have been damaged.
6. Make sure sensor is not aimed within 20 feet of a road.
7. Make sure heat from lights is not triggering sensor. Make sure the sensor is below and as far as possible away from lights..

#### Problem

Sensor is triggered by unwanted movement or heat source.

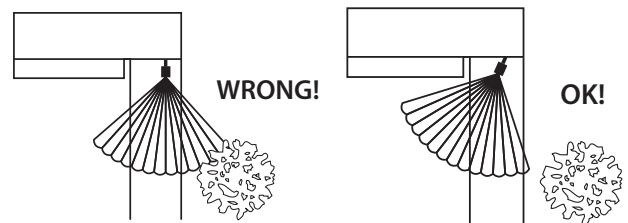

#### Solution

1. Aim sensor away from movement or
2. Mask lens in the direction of the source and/or
3. lower sensitivity control setting.

**Note:** These instructions do not cover all details or variations in equipment nor do they provide for every possible situation during installation, operation or maintenance.

# INSTRUCTIONS

## STL110H/L, STL110HB/L, STL110R/L INSTALLATION



RAB Lighting is committed to creating high-quality, affordable, well-designed and energy-efficient LED lighting and controls that make it easy for electricians to install and end users to save energy. We'd love to hear your comments. Please call the Marketing Department at 888-RAB-1000 or email: [marketing@rablighting.com](mailto:marketing@rablighting.com)

### TECHNICAL TIPS

#### Lights Do Not Turn Off (cont'd)

##### Problem

Movement of tree triggers sensor.

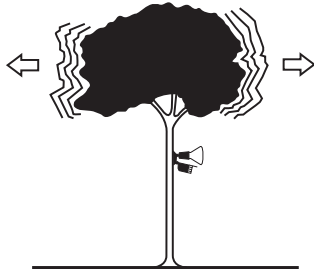

**Solution:** Mount on stable surface.

##### Problem

Passing cars activate sensor.

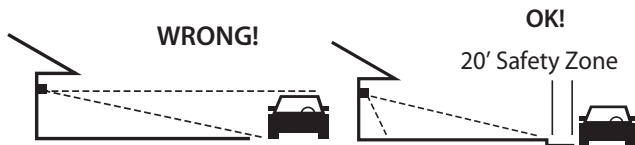

##### Solution

A 20 foot safety zone and lower sensitivity are recommended to avoid activation from passing cars.

#### Lights Turn On and Off Inappropriately

1. Make sure the sensor is installed on its own dedicated circuit, free of motor loads such as HVAC equipment, kitchen appliances or garage door openers.
2. It is not recommended to wire sensors in parallel. More than one sensor wired together makes them difficult to troubleshoot. Disconnect multiple sensors and test separately.
3. Keep all people completely out of the detection pattern to make sure the sensor is not detecting them.
4. Make sure sensor is located below and as far as possible from its lights. Heat from the lights may trigger the sensor.

##### Problem

Heat from the lights may trigger the sensor.

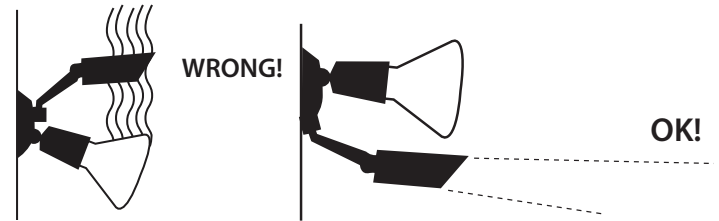

##### Solution

Move sensor below and away from the lights.

5. Moths can be attracted to the lights and fly close to the sensor causing triggering. Reducing the sensitivity may help.
6. Make sure sensor is not aimed within 20 feet of a road or sidewalk. Passing cars will activate sensor.



##### Solution

A 20 foot safety zone and lower sensitivity are recommended to avoid activation from passing cars.

7. Heavy rain, snow or high winds may activate the sensor occasionally. Reduce sensitivity control slightly until problem stops.
8. Make sure lights are not reflecting back into sensor. Check for white or reflective surfaces close to the sensor.

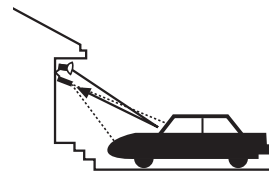

9. Self ballasted PL lamps may cause cycling (on-off).
10. Check Solutions #2, 4, 5, 6, and 7 under "If Lights Do Not Turn Off".

# INSTRUCTIONS

## STL110H/L, STL110HB/L, STL110R/L INSTALLATION



RAB Lighting is committed to creating high-quality, affordable, well-designed and energy-efficient LED lighting and controls that make it easy for electricians to install and end users to save energy. We'd love to hear your comments. Please call the Marketing Department at 888-RAB-1000 or email: [marketing@rablighting.com](mailto:marketing@rablighting.com)

### TECHNICAL TIPS

#### Lights Do Not Turn On

1. Check that lamps and fixtures work. Compare wiring to the wiring diagram in this manual. Check that the power is on.
2. If installing during daylight, remember that the sensor will provide 5 minutes of **Test Time** after power is turned on. After 5 minutes, the sensor will switch to **Automatic Mode** and will not work during daylight if the photocell control is turned to the night only position (*moon symbol*). If you require 5 more minutes of **Test Time**, turn the power off for at least 10 seconds and back on again. If you require the sensor to operate both day and night, turn the center control knob counterclockwise to the sun and moon symbol.
3. Check that lights from another source, such as adjacent porch lights, garden lights or street lights are not in the sensor's view. The sensor's photocell may detect the light and deactivate "daylight". If you desire the sensor to operate in higher ambient light levels, turn the photocell control (*center knob*) toward the sun symbol.
4. Was sensor wired hot? If so circuitry may have been damaged.

#### Lights Turn Off Too Quickly

1. Check if sensor is being "tricked" by reflected light. If lights controlled by the sensor shine or reflect into the photocell (*located behind the lens*) the unit will go on briefly, see its own light, and turn off "thinking" that it is daytime.
2. Check if "R" lamps, non-reflector "A" lamps or self-ballasted PL lamps are being used in a non-enclosed lampholder. If so, switch to reflector PAR floodlight lamps or Quartz floods so the sensor is not affected by stray light. If using PAR floodlights, consider using lower wattage, energy saving lamps.

#### Problem

Lights reflect into photocell, or lights shine directly into photocell

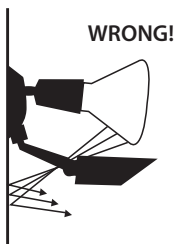

#### Solution

Adjust photocell control (*center knob*) slightly counterclockwise, to allow operation at higher ambient light levels. Alternatively, move the lights or reflectors or mask the lens in the direction of the lights and/or reflections.

#### Range Appears Limited

1. Check that the sensor is level from side to side and pointed at the area you desire. If unit is tilted, part of the detection zone may be high in the air over people's heads.



#### Solution

Position sensor exactly level from side to side.



2. Check that the sensor is not mounted too high. If mounted above 20 feet, much of the usable range will be lost.

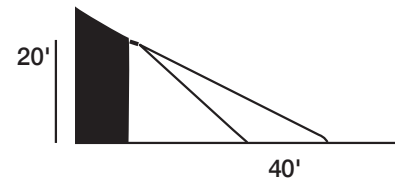

#### Solution

Mounting at 6 feet to 12 feet allows maximum range.

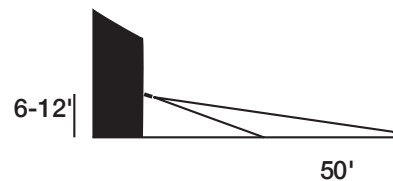

# INSTRUCTIONS

## STL110H/L, STL110HB/L, STL110R/L INSTALLATION



RAB Lighting is committed to creating high-quality, affordable, well-designed and energy-efficient LED lighting and controls that make it easy for electricians to install and end users to save energy. We'd love to hear your comments. Please call the Marketing Department at 888-RAB-1000 or email: [marketing@rablighting.com](mailto:marketing@rablighting.com)

### TECHNICAL TIPS

#### Range Appears Limited (cont'd)

3. Check that movement is not directly towards sensor. Sensor will see movement across its pattern more quickly. To fix, move the sensor.

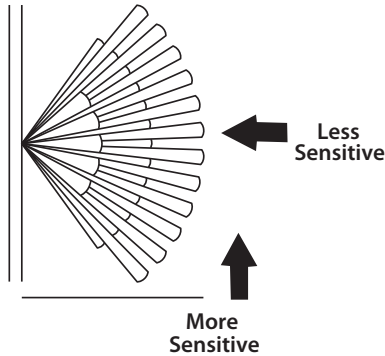

4. Check that movement far away and directly towards sensor is not entirely within one zone.

#### Problem

Sensor will not detect until movement crosses zones

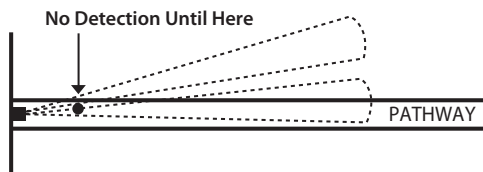

#### Solution

"Micro Adjust" sensor by moving sideways 1/4". This may move the zones to allow earlier detection.

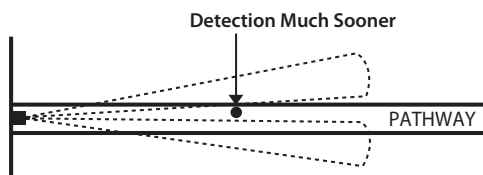

#### Lights Turn On for Unknown Reasons

1. Lights may turn on occasionally during rain, snow and windstorms because the sensor is detecting changes in temperature.

**Solution:** Mount sensor in protected area.

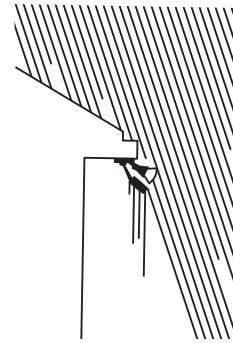

If false detections are a constant problem, reduce sensitivity (turn counterclockwise) until the problem stops.

2. Tilt the sensor lower, it may be seeing distant objects moving.
3. You may not be aware that animals have triggered the sensor. Check sensor aiming to reduce nuisance triggering or mask the lower part of the lens with opaque weatherproof tape to create an "Animal Alley".

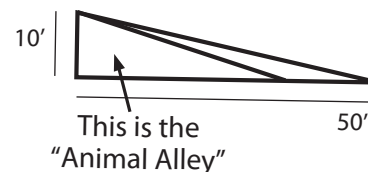

4. Although it is surge and transient protected, the sensor may turn on occasionally during extreme voltage surges.
5. A possible source of "mysterious" sensor activations are strong local radio signals. Check for nearby CB, Ham, VHF radio transmitters, WiFi routers or cellular telephones. The sensor may be activated but will not be permanently impaired by these signals.
6. Check all the Solutions mentioned under "**Lights Turn On and Off**".
7. Check items #2, 4, 5, 6 and 7 under "**Lights Do Not Turn Off**".



#### Easy Answers

[rablighting.com](http://rablighting.com)  
Visit our website for product info

Tech Help Line  
Call our experts: 888 722-1000

e-mail  
Answered promptly - [sales@rablighting.com](mailto:sales@rablighting.com)

Free Lighting Layouts  
Answered online or by request